

Ul. Prądzyńskiego 16 żłobek „MIŚ USZATEK”

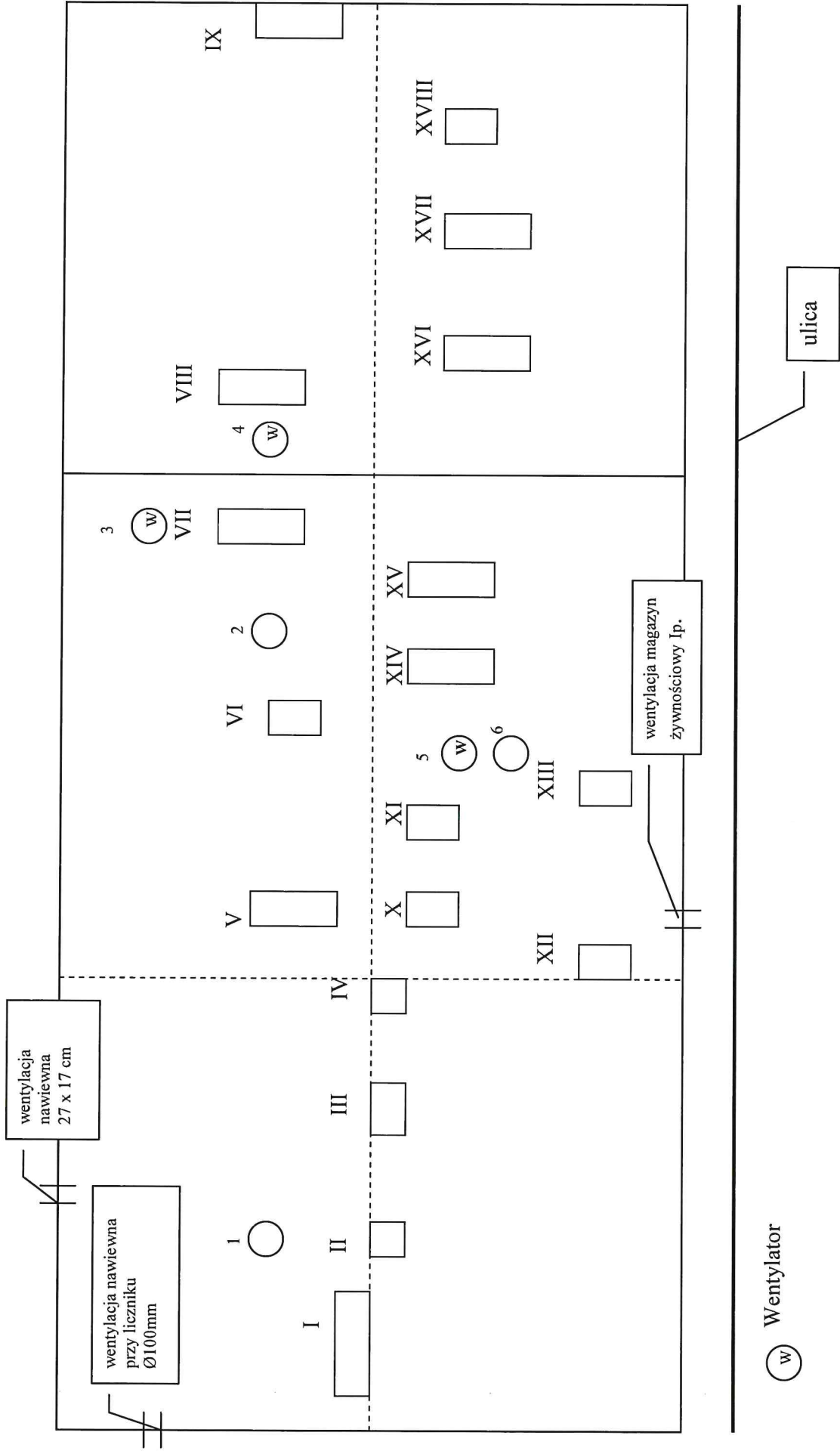

### Grupa kominowa nr I

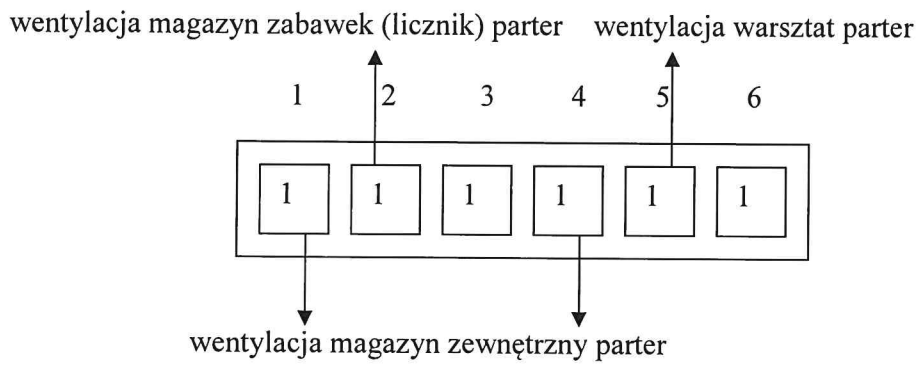

### Grupa kominowa nr II

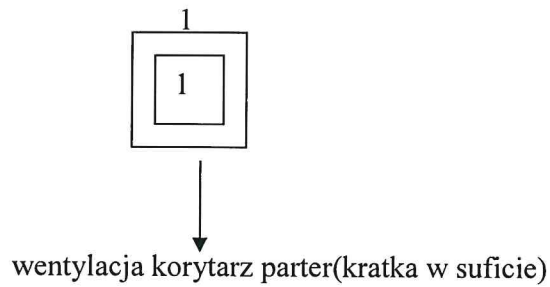
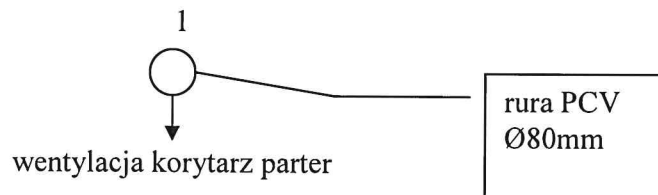

### Grupa kominowa nr III

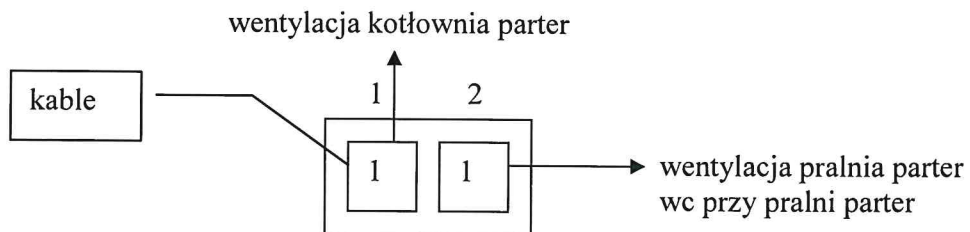

### Grupa kominowa nr IV

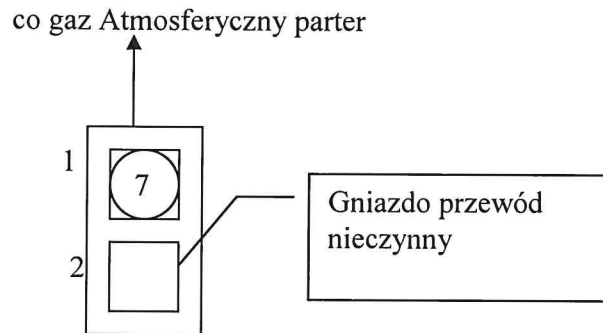

### Grupa kominowa nr V

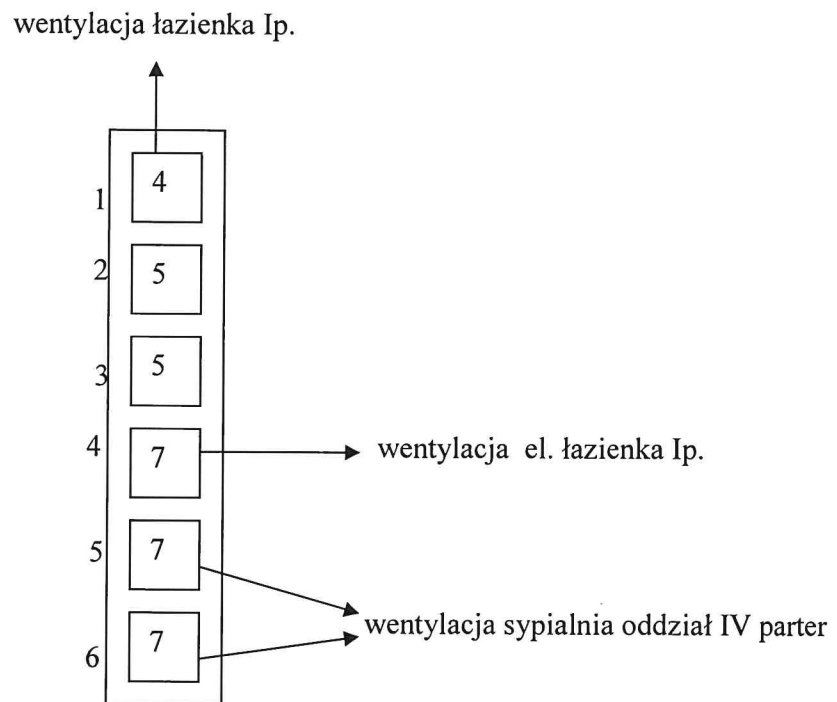

### Grupa kominowa nr VI

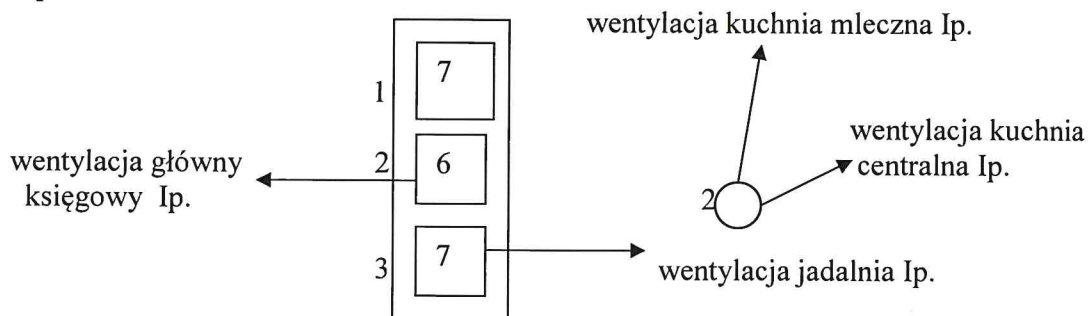

### Grupa kominowa nr VII

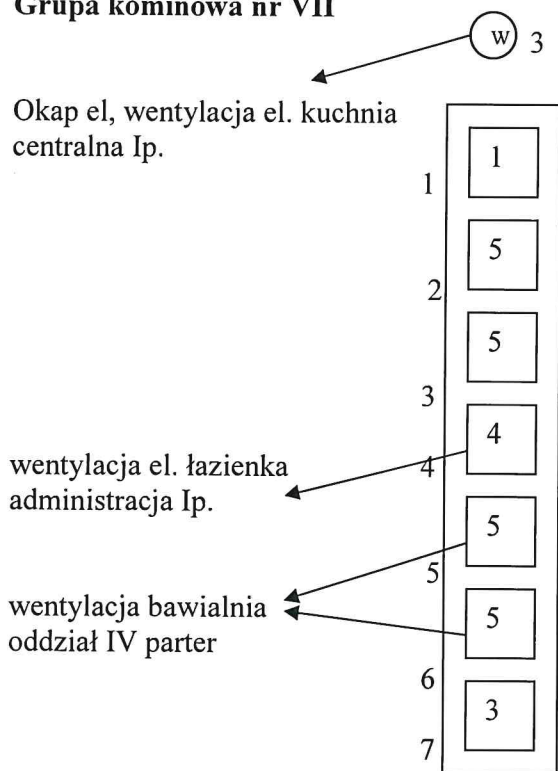

### Grupa kominowa nr VIII

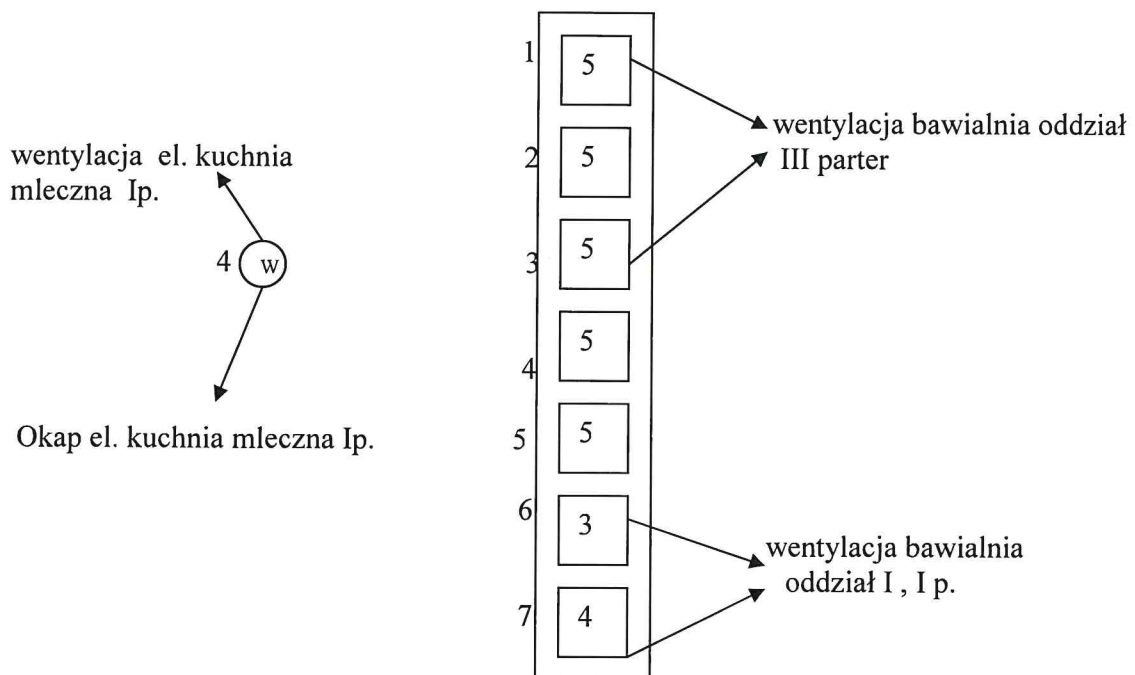

### Grupa kominowa nr IX

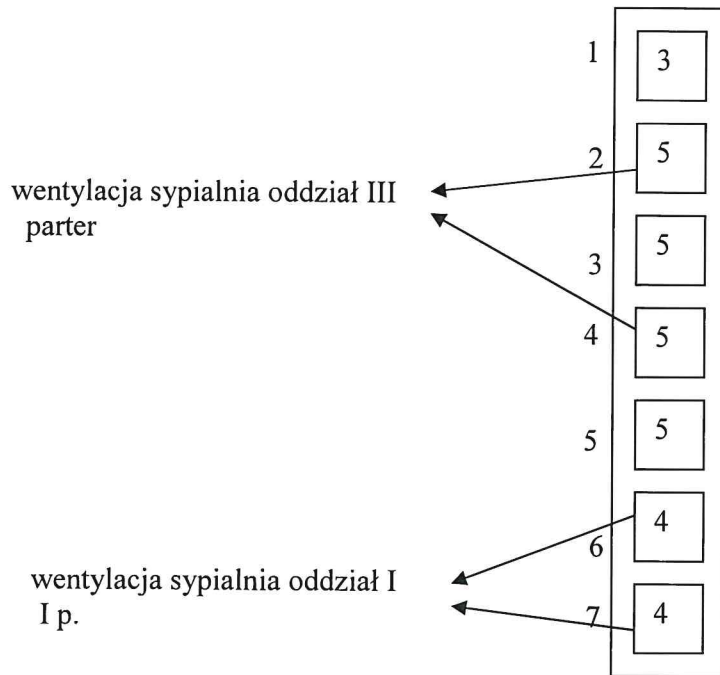

### Grupa kominowa nr X

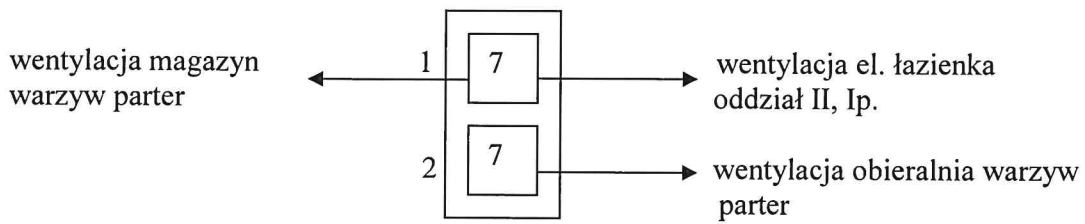

### Grupa kominowa nr XI

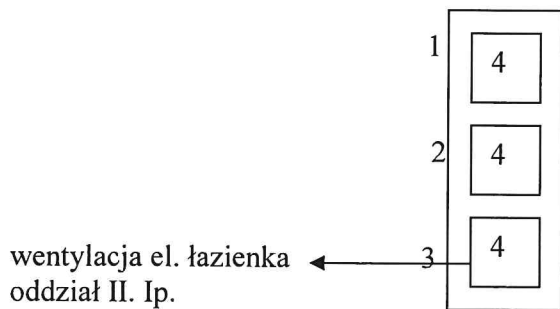

### Grupa kominowa nr XII

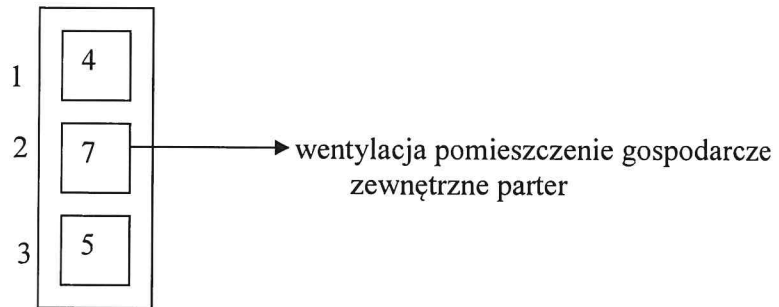

### Grupa kominowa nr XIII

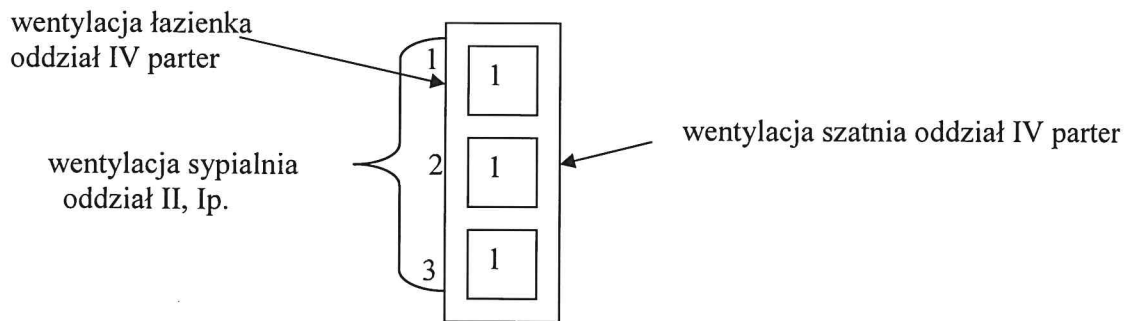

### Grupa kominowa nr XIV

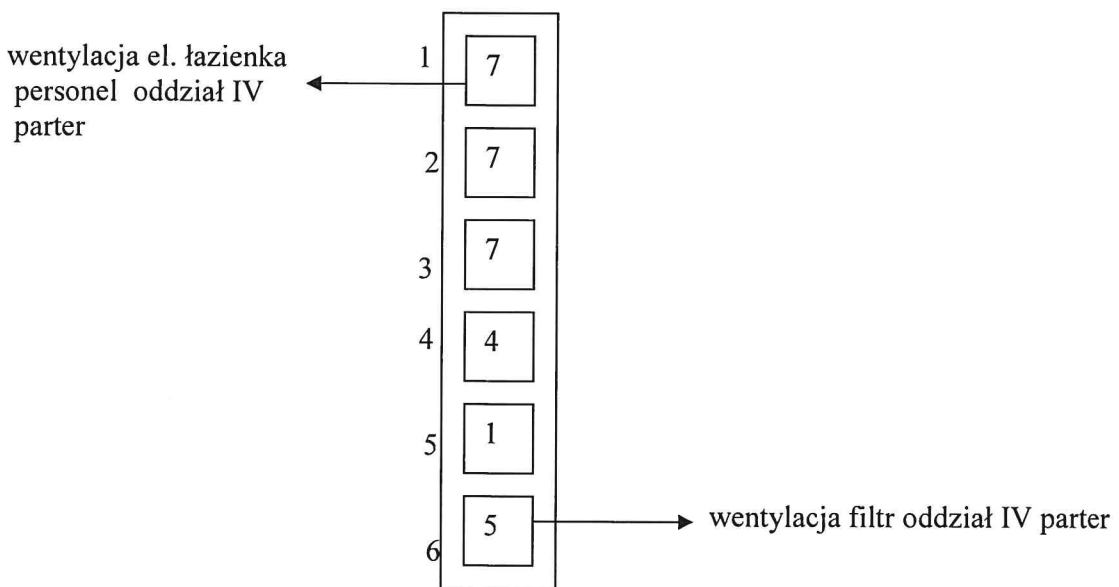

### Grupa kominowa nr XV

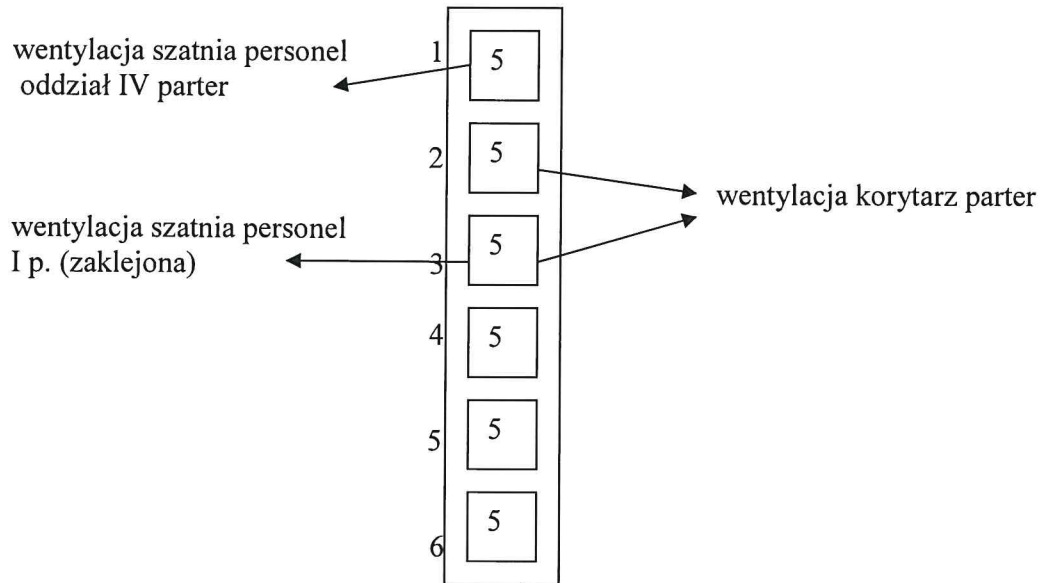

### Grupa kominowa nr XVI

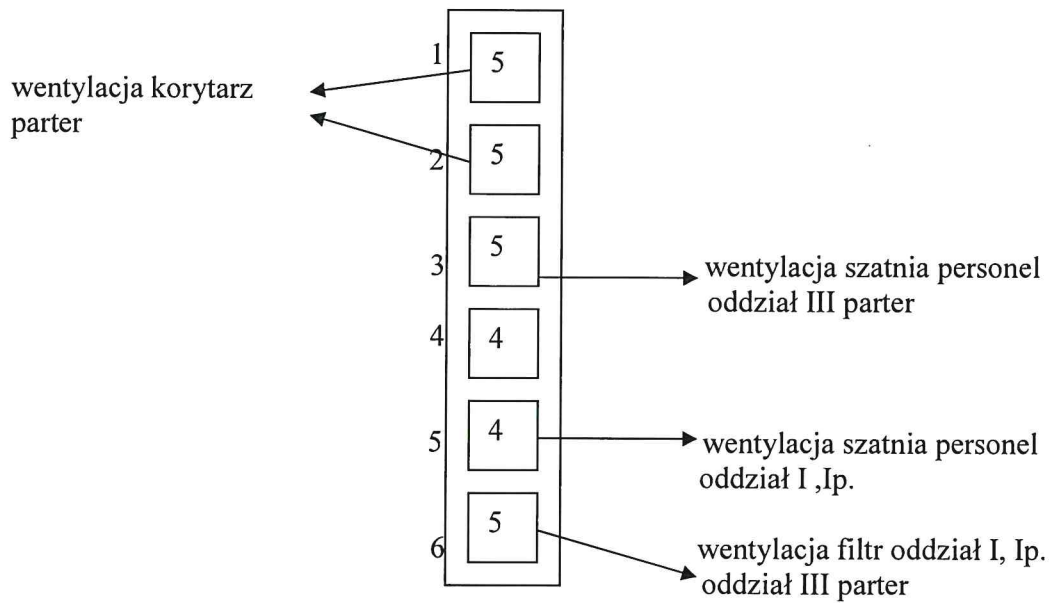

### Grupa kominowa nr XVII

wentylacja łazienka personel oddział III parter, oddział I, Ip.

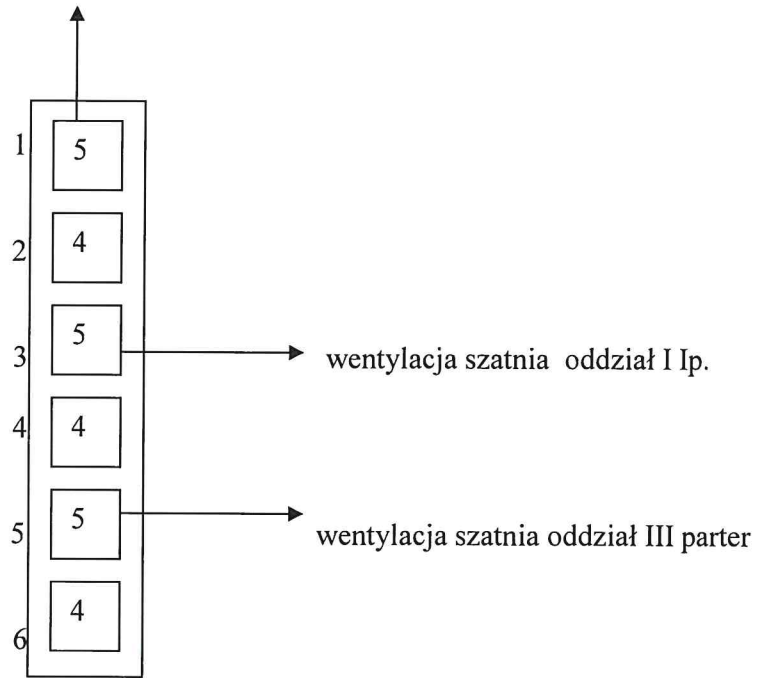

### Grupa kominowa nr XVIII

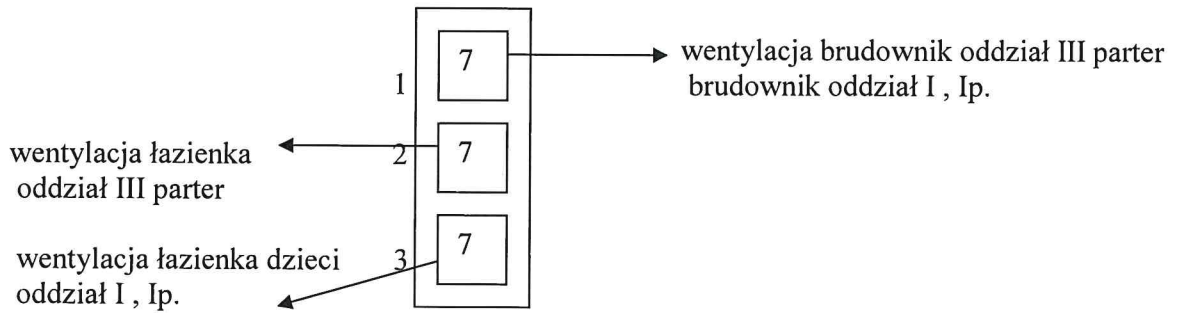



*Zestawienie grup kominowych:*

<b>Grupa kominowa</b>	<b>Ilość przewodów</b>	<b>Ilość podłączeń</b>	<b>Ilość metrów</b>
I	5	4	6
II	1	1	1
III	2	2	2
IV	2	1	7
V	5	4	35
VI	3	2	20
VII	7	3	28
VIII	7	4	32
IX	7	4	31
X	2	3	14
XI	3	1	12
XII	3	1	16
XIII	3	5	3
XIV	6	2	31
XV	6	4	30
XVI	6	5	28
XVII	6	4	27
XVIII	3	4	21
Na dachu	6	7	6
<b>Razem:</b>	<b>77</b>	<b>53</b>	<b>337</b>